

## Technical data sheet

### Polarized retro-reflective photoelectric sensor

Part no.: 50137061

PRK3C.T3/6T-M8



For illustration purposes only

#### Contents

- Technical data
- Dimensioned drawings
- Electrical connection
- Diagrams
- Operation and display
- Reflectors & reflective tapes
- Part number code
- Notes
- Further information
- Accessories



## Technical data

### Basic data

|                     |   |
|---------------------|---|
| Series              | 3C  |
| Operating principle | Reflection principle  |
| Application         | Detection of highly transparent bottles<br>Detection of transparent films |

### Special version

|                 |                                |
|-----------------|--------------------------------|
| Special version | Autocollimation<br>Teach input |
|-----------------|--------------------------------|

### Optical data

|                          |   |
|--------------------------|---|
| Operating range          | 0 ... 3 m                                 |
| Operating range          | Guaranteed operating range                |
| Reference reflector      | With reflector TK(S) 100x100              |
| Operating range limit    | Typical operating range                   |
| Operating range limit    | 0 ... 3.6 m, With reflector TK(S) 100x100 |
| Light source             | LED, Red                                  |
| Wavelength               | 635 nm                                    |
| Transmitted-signal shape | Pulsed                                    |
| LED group                | Exempt group (in acc. with EN 62471)      |

### Electrical data

|                    |   |
|--------------------|---|
| Protective circuit | Polarity reversal protection<br>Short circuit protected |
|--------------------|---|

#### Performance data

|                      |  |
|----------------------|--|
| Supply voltage $U_B$ | 10 ... 30 V, DC, Incl. residual ripple |
| Residual ripple      | 0 ... 15 %, From $U_B$                 |
| Open-circuit current | 0 ... 15 mA                            |

#### Inputs

|                        |            |
|------------------------|------------|
| Number of teach inputs | 1 Piece(s) |
|------------------------|------------|

#### Teach inputs

|                   |   |
|-------------------|---|
| Voltage type      | DC  |
| Switching voltage | high: $\geq 0.65 \times U_B$<br>low: $\leq 0.35 \times U_B$ |
| Delay             | 1 ms  |
| Input resistance  | 20,000 $\Omega$   |

#### Teach input 1

|                        |  |
|------------------------|--|
| Assignment             | Connection 1, pin 2  |
| Function               | Keyboard lockout<br>Light/dark switching<br>Sensitivity adjustment |
| Active switching state | High   |

#### Outputs

|                                     |            |
|-------------------------------------|------------|
| Number of digital switching outputs | 1 Piece(s) |
|-------------------------------------|------------|

#### Switching outputs

|                         |  |
|-------------------------|--|
| Voltage type            | DC   |
| Switching current, max. | 100 mA                                     |
| Switching voltage       | high: $\geq (U_B - 2V)$<br>low: $\leq 2 V$ |

#### Switching output 1

|                     |  |
|---------------------|--|
| Assignment          | Connection 1, pin 4                        |
| Switching element   | Transistor, Push-pull                      |
| Switching principle | Light switching (PNP)/dark switching (NPN) |

### Time behavior

|                     |             |
|---------------------|-------------|
| Switching frequency | 1,500 Hz    |
| Response time       | 0.33 ms     |
| Readiness delay     | 300 ms      |
| Response jitter     | 110 $\mu$ s |

### Connection

#### Connection 1

|                    |   |
|--------------------|---|
| Function           | Signal IN<br>Signal OUT<br>Voltage supply |
| Type of connection | Connector                                 |
| Thread size        | M8  |
| Type               | Male                                      |
| Material           | Metal                                     |
| No. of pins        | 4 -pin                                    |

### Mechanical data

|                            |   |
|----------------------------|---|
| Dimension (W x H x L)      | 11.4 mm x 34.2 mm x 18.3 mm                           |
| Housing material           | Plastic   |
| Plastic housing            | PC-ABS  |
| Lens cover material        | Plastic / PMMA  |
| Net weight                 | 10 g  |
| Housing color              | Red   |
| Type of fastening          | Through-hole mounting<br>Via optional mounting device |
| Compatibility of materials | ECOLAB  |

### Operation and display

|                                     |                        |
|-------------------------------------|------------------------|
| Type of display                     | LED                    |
| Number of LEDs                      | 2 Piece(s)             |
| Operational controls                | Teach button           |
| Function of the operational control | Sensitivity adjustment |

### Environmental data

|                                |               |
|--------------------------------|---------------|
| Ambient temperature, operation | -40 ... 60 °C |
| Ambient temperature, storage   | -40 ... 70 °C |

### Certifications

|                      |                 |
|----------------------|-----------------|
| Degree of protection | IP 67<br>IP 69K |
| Protection class     | III             |
| Certifications       | c UL US         |
| Standards applied    | IEC 60947-5-2   |

# Technical data

|                       |          |
|-----------------------|----------|
| Customs tariff number | 85365019 |
| ECLASS 5.1.4          | 27270902 |
| ECLASS 8.0            | 27270902 |
| ECLASS 9.0            | 27270902 |
| ECLASS 10.0           | 27270902 |
| ECLASS 11.0           | 27270902 |
| ECLASS 12.0           | 27270902 |
| ECLASS 13.0           | 27270902 |
| ECLASS 14.0           | 27270902 |
| ETIM 5.0              | EC002717 |
| ETIM 6.0              | EC002717 |
| ETIM 7.0              | EC002717 |
| ETIM 8.0              | EC002717 |
| ETIM 9.0              | EC002717 |

# Dimensioned drawings

All dimensions in millimeters

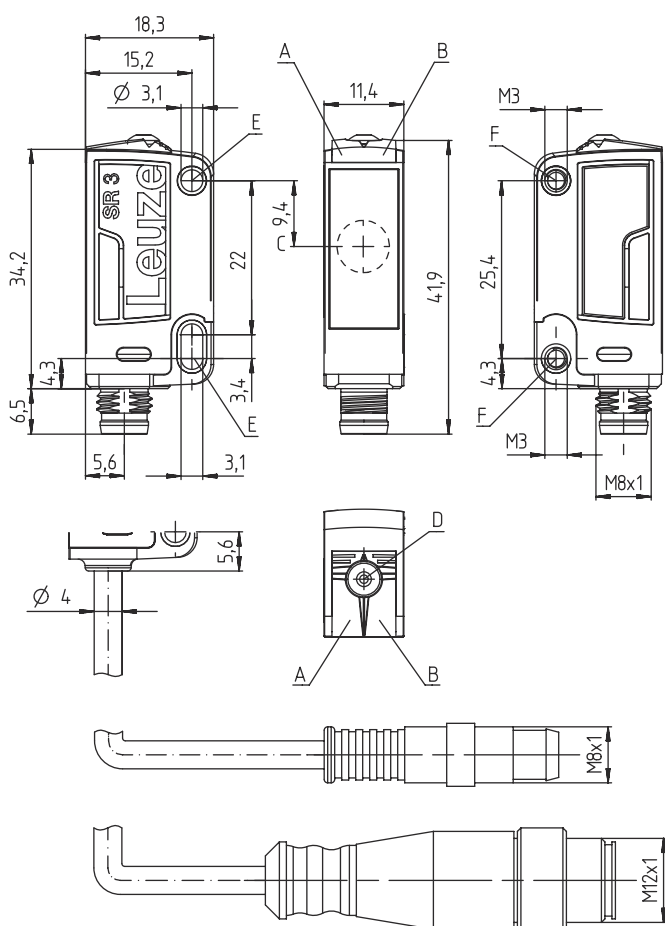

- A Green LED
- B Yellow LED
- C Optical axis
- D Teach button
- E Mounting sleeve (standard)
- F Threaded sleeve (3C.B series)

# Electrical connection

## Connection 1

|                    |                |
|--------------------|----------------|
| Function           | Signal IN      |
|                    | Signal OUT     |
|                    | Voltage supply |
| Type of connection | Connector      |
| Thread size        | M8             |
| Type               | Male           |
| Material           | Metal          |
| No. of pins        | 4 -pin         |

| Pin | Pin assignment |
|-----|----------------|
| 1   | V+             |
| 2   | Teach-in       |
| 3   | GND            |
| 4   | OUT 1          |

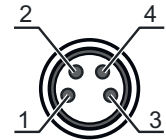

## Diagrams

### Typ. response behavior

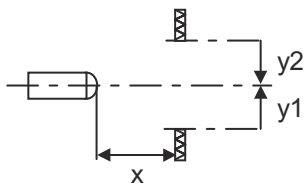
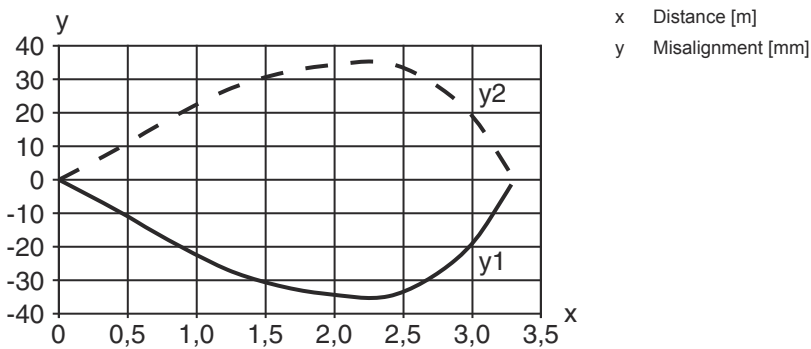



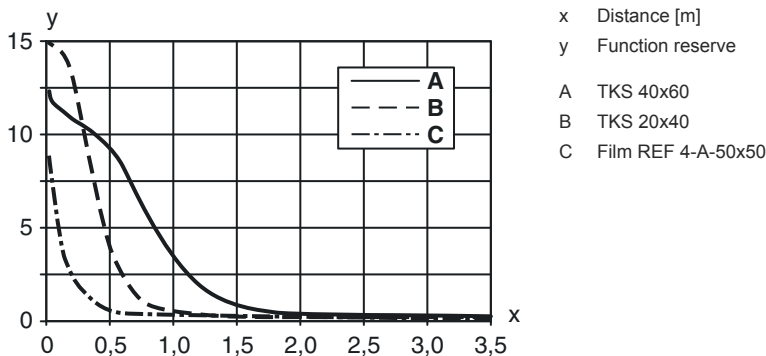



### Typ. function reserve



## Operation and display

| LED | Display                  | Meaning               |
|-----|--------------------------|-----------------------|
| 1   | Green, continuous light  | Operational readiness |
| 2   | Yellow, continuous light | Light path free       |

## Reflectors & reflective tapes

|   | Part no. | Designation   | Operating range<br>Operating range<br>limit | Description  |
|---|----------|---------------|---|--|
|    | 50117583 | MTKS 50x50.1  | 0 ... 1.3 m<br>0 ... 1.6 m                  | Design: Rectangular<br>Triple reflector size: 1.2 mm<br>Reflective surface: 50 mm x 50 mm<br>Material: Plastic<br>Base material: Plastic<br>Chemical designation of the material: PMMA8N<br>Fastening: Through-hole mounting, Adhesive |
|     | 50110192 | REF 6-A-50x50 | 0 ... 1.2 m<br>0 ... 1.4 m                  | Design: Rectangular<br>Triple reflector size: 0.3 mm<br>Reflective surface: 50 mm x 50 mm<br>Material: Plastic<br>Chemical designation of the material: PMMA<br>Fastening: Self-adhesive   |
|   | 50003192 | TK 100x100    | 0 ... 3 m<br>0 ... 3.6 m                    | Design: Rectangular<br>Triple reflector size: 4 mm<br>Reflective surface: 96 mm x 96 mm<br>Material: Plastic<br>Base material: Plastic<br>Chemical designation of the material: PMMA8N<br>Fastening: Rear side can be glued            |
|  | 50022816 | TKS 100X100   | 0 ... 3 m<br>0 ... 3.6 m                    | Design: Rectangular<br>Triple reflector size: 4 mm<br>Reflective surface: 96 mm x 96 mm<br>Material: Plastic<br>Base material: Plastic<br>Chemical designation of the material: PMMA8N<br>Fastening: Through-hole mounting, Adhesive   |
|  | 50081283 | TKS 20X40     | 0 ... 1 m<br>0 ... 1.2 m                    | Design: Rectangular<br>Triple reflector size: 2.3 mm<br>Reflective surface: 16 mm x 38 mm<br>Material: Plastic<br>Base material: Plastic<br>Chemical designation of the material: PMMA8N<br>Fastening: Through-hole mounting, Adhesive |
|  | 50040820 | TKS 40X60     | 0 ... 2 m<br>0 ... 2.4 m                    | Design: Rectangular<br>Triple reflector size: 4 mm<br>Reflective surface: 37 mm x 56 mm<br>Material: Plastic<br>Base material: Plastic<br>Chemical designation of the material: PMMA8N<br>Fastening: Through-hole mounting, Adhesive   |

## Part number code

Part designation: AAA 3C d EE-f.GG H/i J-K

### AAA3C

#### Operating principle / construction

HT3C: Diffuse reflection sensor with background suppression  
 LS3C: Throughbeam photoelectric sensor transmitter  
 LE3C: Throughbeam photoelectric sensor receiver  
 PRK3C: Retro-reflective photoelectric sensor with polarization filter  
 ODT3C: Distance diffuse sensor with background suppression

## Part number code

|           |  |
|-----------|--|
| <b>d</b>  | <b>Light type</b><br>n/a: red light<br>l: infrared light   |
| <b>EE</b> | <b>Light source</b><br>n/a: LED<br>L1: laser class 1<br>L2: laser class 2  |
| <b>f</b>  | <b>Preset range (optional)</b><br>n/a: operating range acc. to data sheet<br>xxxF: Preset range [mm]<br>2M: operating range of 2 meters  |
| <b>GG</b> | <b>Equipment</b><br>n/a: standard<br>A: Autocollimation principle (single lens) for positioning tasks<br>B: Housing model with two M3 threaded sleeves, brass<br>F: Permanently set range<br>L: Long light spot<br>S: small light spot<br>T: autocollimation principle (single lens) for highly transparent bottles without tracking<br>TT: autocollimation principle (single lens) for highly transparent bottles with tracking<br>V: V-optics<br>XL: Extra long light spot<br>X: extended model<br>HF: Suppression of HF illumination (LED)  |
| <b>H</b>  | <b>Operating range adjustment</b><br>n/a with HT: range adjustable via 8-turn potentiometer<br>n/a with retro-reflective photoelectric sensors (PRK): operating range not adjustable<br>1: 270° potentiometer<br>3: teach-in via button<br>6: auto-teach   |
| <b>i</b>  | <b>Switching output/function OUT 1/IN: Pin 4 or black conductor</b><br>2: NPN transistor output, light switching<br>N: NPN transistor output, dark switching<br>4: PNP transistor output, light switching<br>P: PNP transistor output, dark switching<br>6: push-pull switching output, PNP light switching, NPN dark switching<br>G: Push-pull switching output, PNP dark switching, NPN light switching<br>L: IO-Link interface (SIO mode: PNP light switching, NPN dark switching)<br>8: activation input (activation with high signal)<br>X: pin not used<br>1: IO-Link / light switching (NPN) / dark switching (PNP) |
| <b>J</b>  | <b>Switching output / function OUT 2/IN: pin 2 or white conductor</b><br>2: NPN transistor output, light switching<br>N: NPN transistor output, dark switching<br>4: PNP transistor output, light switching<br>P: PNP transistor output, dark switching<br>6: push-pull switching output, PNP light switching, NPN dark switching<br>G: Push-pull switching output, PNP dark switching, NPN light switching<br>W: warning output<br>X: pin not used<br>8: activation input (activation with high signal)<br>9: deactivation input (deactivation with high signal)<br>T: teach-in via cable                                 |
| <b>K</b>  | <b>Electrical connection</b><br>n/a: cable, standard length 2000 mm, 4-wire<br>5000: cable, standard length 5000 mm, 4-wire<br>M8: M8 connector, 4-pin (plug)<br>M8.3: M8 connector, 3-pin (plug)<br>200-M8: cable, length 200 mm with M8 connector, 4-pin, axial (plug)<br>200-M8.3: cable, length 200 mm with M8 connector, 3-pin, axial (plug)<br>200-M12: cable, length 200 mm with M12 connector, 4-pin, axial (plug)   |

### Note



A list with all available device types can be found on the Leuze website at [www.leuze.com](http://www.leuze.com).

## Notes

|                              |   |
|------------------------------|---|
| <b>Observe intended use!</b> |   |
|                              | <ul style="list-style-type: none"> <li>⌘ This product is not a safety sensor and is not intended as personnel protection.</li> <li>⌘ The product may only be put into operation by competent persons.</li> <li>⌘ Only use the product in accordance with its intended use.</li> </ul> |

|                             |   |
|-----------------------------|---|
| <b>For UL applications:</b> |   |
|                             | <ul style="list-style-type: none"> <li>⌘ For UL applications, use is only permitted in Class 2 circuits in accordance with the NEC (National Electric Code).</li> <li>⌘ These proximity switches shall be used with UL Listed Cable assemblies rated 30V, 0.5A min, in the field installation, or equivalent (categories: CYJV/ CYJV7 or PVVA/PVVA7)</li> </ul> |

## Further information

- Light source: Average life expectancy 100,000 h at an ambient temperature of 25 °C
- Response time: For short decay times, an ohmic load of approx. 5kOhm is recommended
- Sum of the output currents for both outputs, 50 mA for ambient temperatures > 40 °C
- The light spot may not exceed the reflector.
- Use of micro-triad-type reflectors beginning with MTK(S) or REF 6-A- reflective tape is preferred.
- For REF 6-A- reflective tape, the sensor's side edge must be aligned parallel to the side edge of the reflective tape.
- The push-pull switching outputs must not be connected in parallel.

## Accessories

### Connection technology - Connection cables

|          | Part no. | Designation       | Article          | Description  |
|----------|----------|-------------------|------------------|--|
| <br><br> | 50130850 | KD U-M8-4A-V1-050 | Connection cable | Connection 1: Connector, M8, Axial, Female, 4 -pin<br>Connector, LED: No<br>Connection 2: Open end<br>Shielded: No<br>Cable length: 5.000 mm<br>Sheathing material: PVC  |
| <br><br> | 50130871 | KD U-M8-4W-V1-050 | Connection cable | Connection 1: Connector, M8, Angled, Female, 4 -pin<br>Connector, LED: No<br>Connection 2: Open end<br>Shielded: No<br>Cable length: 5.000 mm<br>Sheathing material: PVC |

## Accessories

### Mounting technology - Mounting brackets

|   | Part no. | Designation | Article         | Description  |
|---|----------|-------------|-----------------|--|
|  | 50060511 | BT 3        | Mounting device | Design of mounting device: Angle, L-shape<br>Fastening, at system: Through-hole mounting<br>Mounting bracket, at device: Screw type<br>Type of mounting device: Rigid<br>Material: Metal |

### Mounting technology - Rod mounts

|   | Part no. | Designation  | Article         | Description  |
|---|----------|--------------|-----------------|--|
|  | 50117255 | BTU 200M-D12 | Mounting system | Design of mounting device: Mounting system<br>Fastening, at system: For 12 mm rod, Sheet-metal mounting<br>Mounting bracket, at device: Screw type, Suited for M3 screws<br>Type of mounting device: Clampable, Adjustable, Turning, 360°<br>Material: Metal |

### Micro-triad-type reflectors

|   | Part no. | Designation  | Article   | Description  |
|---|----------|--------------|-----------|--|
|  | 50117583 | MTKS 50x50.1 | Reflector | Design: Rectangular<br>Triple reflector size: 1.2 mm<br>Reflective surface: 50 mm x 50 mm<br>Material: Plastic<br>Base material: Plastic<br>Chemical designation of the material: PMMA8N<br>Fastening: Through-hole mounting, Adhesive |

### Reflective tapes for laser and clear-glass applications

|   | Part no. | Designation | Article   | Description  |
|---|----------|-------------|-----------|--|
|  | 50109257 | TKS 40x60.1 | Reflector | Design: Rectangular<br>Triple reflector size: 2.3 mm<br>Reflective surface: 37 mm x 56 mm<br>Material: Plastic<br>Base material: Plastic<br>Chemical designation of the material: PMMA8N<br>Fastening: Through-hole mounting, Adhesive |

#### Note



A list with all available accessories can be found on the Leuze website in the Download tab of the article detailed page.