

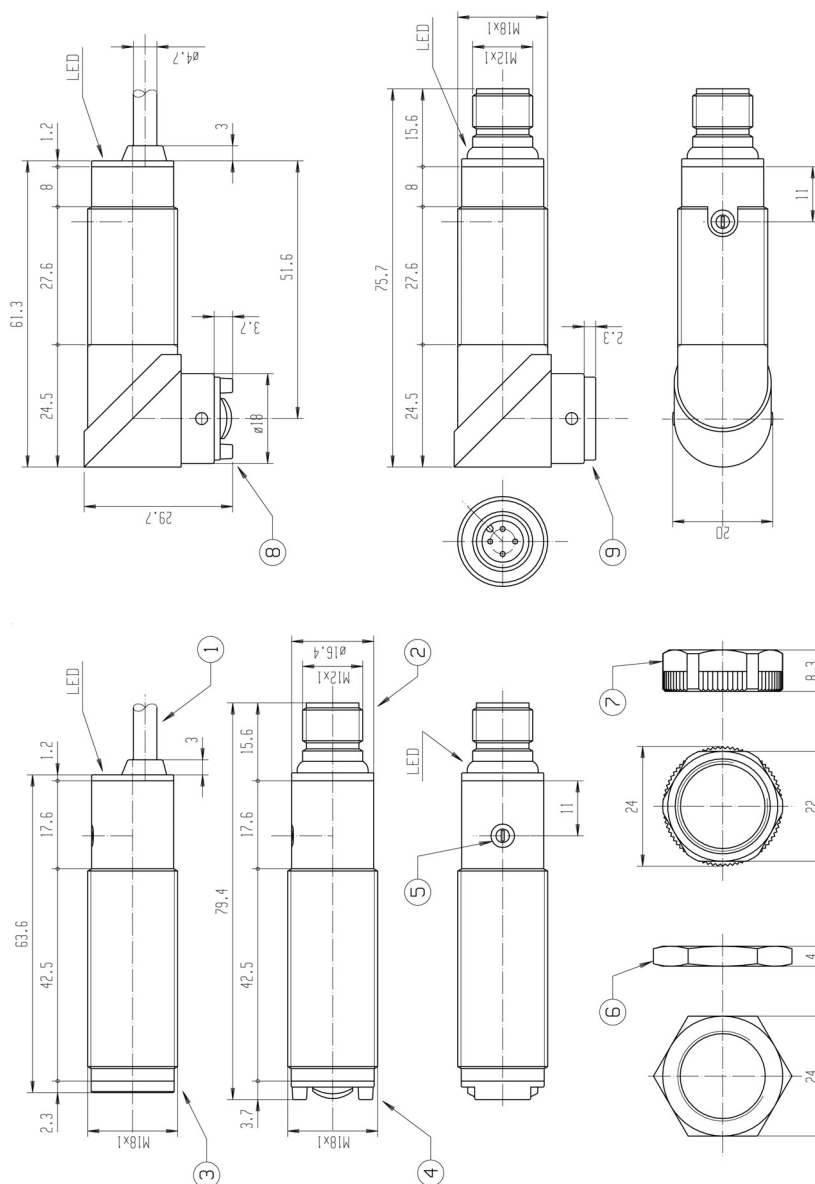

- Modelli con regolazione laterale con ottica assiale ed a 90°
- Modelli con distanza di rilevazione maggiorata (SS8, SS9)
- Stato dell'uscita Light-on/Dark-on selezionabile
- Contenitori di lunghezza ridotta
- Frequenza di commutazione aumentata (250Hz)
- Grado di protezione IP 67 per tutti i modelli
- Indicatore LED su tutti i modelli
- Totalmente protetti contro danneggiamenti di tipo elettrico

- Models with side sens. adjustment on axial and right angle optic
- Models with increased sensing distance (SS8, SS9)
- Light-on/Dark-on selectable output
- Housing with reduced length
- Increased switching frequency (250 Hz)
- IP 67 protection degree for all models
- LED status indicator for all versions
- Complete protection against electrical damages

Dimensioni - dimension



- 1 ■ Uscita cavo, 4x0,34 mm²
Ø 4,7 mm, PVC, 2 m
- 2 ■ Uscita connettore M12
- 3 ■ Ottica assiale per modelli
A;B;2;3;4;5;6;7
- 4 ■ Ottica assiale per modelli
0;1;8;9;C;P;T
- 5 ■ Trimmer regolazione
sensibilità
- 6 ■ Ghiera metallica
- 7 ■ Ghiera plastica
- 8 ■ Ottica a 90° per modelli
0;1;8;9;C;P;T
- 9 ■ Ottica a 90° per modelli
A;B;2;3;4;5;6;7

- 1 ■ Cable exit 4x0,34 mm²
Ø 4,7 mm, PVC, 2 m
- 2 ■ M12 plug cable exit
- 3 ■ Axial optic for
A;B;2;3;4;5;6;7 models
- 4 ■ Axial optic for
0;1;8;9;C;P;T models
- 5 ■ Sensitivity adjustment
trimmer
- 6 ■ Metal tightening nut
- 7 ■ Plastic tightening nut
- 8 ■ Right angle optic for
0;1;8;9;C;P;T models
- 9 ■ Right angle optic for
A; B; 2; 3; 4; 5; 6; 7 models

M18 photoelectric sensors with side sens. adjustment - DC



Identificazione modelli - Ordering system

SS A / O N - O A 3X	
serie/serie	
fotocellula M18 con ottica assiale <i>M18 photoelectric sensors with axial optic</i>	SS
fotocellula M18 ottica a 90° <i>M18 photoelectric sensors with right angle</i>	SP
modelli/models	
soppressione di sfondo 50mm senza regolazione <i>50mm background suppr. without sens. adjust.</i>	0 ¹
soppressione di sfondo 100mm senza regolazione <i>100mm background suppr. without sens. adjust.</i>	1 ¹
riflessione diretta 50mm senza regolazione <i>50mm diffuse reflection without sens. adjust.</i>	A
riflessione diretta 50mm con regolazione <i>50mm diffuse reflection with sens. adjust.</i>	B
riflessione diretta 100mm senza regolazione <i>100mm diffuse reflection without sens. adjust.</i>	2
riflessione diretta 100mm con regolazione <i>100mm diffuse reflection with sens. adjust.</i>	3
riflessione diretta 200mm con regolazione <i>200mm diffuse reflection with sens. adjust.</i>	4
riflessione diretta 200mm senza regolazione <i>200mm diffuse reflection without sens. adjust.</i>	5
riflessione diretta 400mm senza regolazione <i>400mm diffuse reflection without sens. adjust.</i>	6
riflessione diretta 400mm con regolazione <i>400mm diffuse reflection with sens. adjust.</i>	7
riflessione diretta 800mm con regolazione <i>800mm diffuse reflection with sens. adjust.</i>	8
riflessione diretta 800mm senza regolazione <i>800mm diffuse reflection without sens. adjust.</i>	9
con catarifrangente 4m senza regolazione <i>4m retro-reflective without sens. adjust.</i>	C
con catarifrangente polarizzata 3m senza regolazione <i>3m polarised retro-reflective without sens. adjust.</i>	P
emettitore 14m senza regolazione <i>14m emitter without sens. adjust.</i>	H
ricevitore 14m senza regolazione <i>14m receiver without sens. adjust.</i>	Z
ricevitore 14m con regolazione <i>14m receiver with sens. adjust.</i>	D
	3X
	Polarizzata con regolazione di sensibilità <i>Polarized with sens. adjust</i>
	A
	E
	uscita cavo/cable exit
	uscita cavo assiale <i>axial cable exit</i>
	uscita connettore M12 <i>M12 plug cable exit</i>
	O
	1
	contenitore/housing
	contenitore plastico <i>plastic housing</i>
	contenitore metallico <i>metallic housing</i>
	O
	N
	P
	logica/logic
	emettitore <i>emitter</i>
	uscita NPN <i>NPN output</i>
	uscita PNP <i>PNP output</i>
	O
	X
	L
	D
	stato uscita/output state
	emettitore senza check - LOn/DOn selez. <i>emitter without check - LOn/DOn selectable</i>
	emettitore con check <i>emitter with check</i>
	3 fili - impulso luce <i>3 wires - Light ON</i>
	3 fili - impulso buio <i>3 wires - Dark ON</i>

1 Solo versione SS/SS only
2 12 mm con focalizzatore STF-12; 25mm con focalizzatore STF-25
12mm with focalizer STF-12; 25mm with focalizer STF-25
Focalizzatore da ordinare separatamente
The focalizer have to be ordered separately

Connettori - Connectors

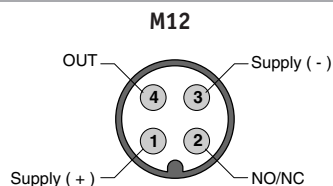

Tasteggio diretto/Diffuse reflection
Polarizzata/Polarized
Ricevitore/Receiver
Soppressione di sfondo/Background suppr.

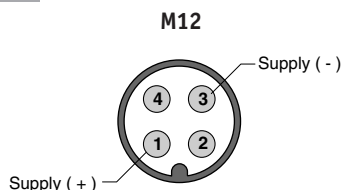

Emettitori senza check
Emitters without check

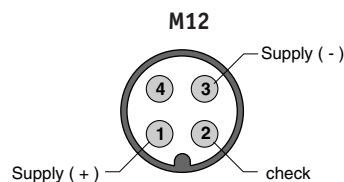

Emettitori con check
Emitters with check

serie SS-SP - serie SS-SP



Specifiche - Specifications

Tutti i modelli / All models	soppressione di sfondo background suppr.	riflessione diretta diffuse reflection	catarifrangente with reflex	polarizzata polarized	barriere through-beam
Modello / Model	⁽¹⁾ 0 ⁽¹⁾ 1 ^{(1) (3)} T	⁽¹⁾ A ⁽¹⁾ 2 ⁽¹⁾ 5 ⁽¹⁾ 6 ⁽¹⁾ 9	⁽²⁾ C	⁽¹⁾ P	⁽¹⁾ H ⁽¹⁾ Z ⁽¹⁾ D
Distanza di rilevazione nominale Nominal sensing distance	50mm 100mm 12/25mm	50mm ⁽⁴⁾ 100mm ⁽⁴⁾ 200mm ⁽⁵⁾ 400mm ⁽⁵⁾ 800mm ⁽⁶⁾	4m ⁽⁷⁾	3m ⁽⁷⁾	14m 14m
Emissione / Emission	rosso/red	infrarosso / infrared		rosso/red	infrarosso/infrared
Diametro spot / Spot diameter	2mm 4,5mm 1mmSTF-12 2mmSTF-25				
Oggetto minimo rilevabile Minimum detectable object	1mm 3,5mm 0,1mmSTF-12 0,25mmSTF-25				
Corsa differenziale / Differential travel	≤10%				
Ripetibilità / Repeat accuracy	5%				
Tensione di alimentazione Operating voltage	10-30Vdc				
Ondulazione residua / Ripple	≤10%				
Corrente assorbita No-load supply current	30mA				2x25mA
Corrente di uscita / Load current	100mA				
Corrente di perdita / Leakage current	≤10μA				
Caduta di tensione in uscita Output voltage drop	1,2V max. I _L =100mA				
Tipo uscita / Output type	NPN o/or PNP - LO _n /DO _n selezionabile/selectable				
Frequenza di commutazione Switching frequency	1KHz	250Hz			
Ritardo alla disponibilità Time delay before availability	200ms				
Protezioni elettriche alimentazione Supply electrical protections	inversione di polarità, sovratensioni impulsive polarity reversal, transient				
Protezioni elettriche uscita Output electrical protections	cortocircuito (autoripristinante) short circuit (autoreset)				
Limiti di temperatura Temperature range	-25°...+70° (senza condensa / without freeze)				
Deriva termica / Temperature drift	10% Sr				
Interferenza alla luce esterna Interference to external light	3000lux (lampada ad incandescenza / incandescent lamp); 10000lux (luce solare / sunlight)				
Grado di protezione Protection degree	IP67 ⁽⁸⁾ (EN60529)				
Indicatori LED / LED indicators	giallo / yellow				
Materiale contenitore Housing material	PBT (plastico), ottone nichelato (metallico), PC (passacavo); PBT (plastic), nickel-plated brass (metal), PC (cable exit)				
Materiale ottica / Optic material	PMMA				
Coppia serraggio / Tightening torque	40 Nm (corpo metallico / metal housing)				
Peso (appross.) / Weight (approx.)	100g (plastico / plastic), 120g (metallico / metal)				200g, 240g

(1) senza regolazione della sensibilità; (2) con regolazione della sensibilità; (3) 12 mm con focalizzatore STF12, 25 mm con focalizzatore STF25 (4) con target bianco 100x100 mm (5) con target bianco 200x200 mm (6) con target bianco 400x400 mm (7) con riflettore RL110 (8) protezione garantita solo con il cavo a connettore montato (1) without sensitivity adjustment; (2) with sensitivity adjustment; (3) 12 mm with focalizer STF12, 25 mm with focalizer STF25, (4) with 100x100 white paper (5) with 200x200 white paper (6) with 400x400 white paper (7) with RL110 reflector (8) protection guaranteed only with plug cable mounted

Connessioni - Wiring diagrams

NPN uscita/output

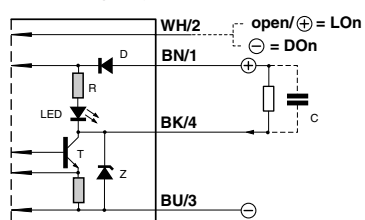

PNP uscita/output

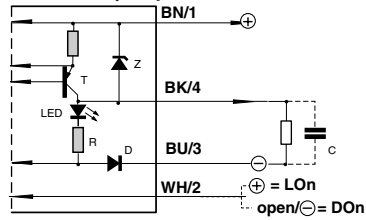

emettitori con check/emitter with check

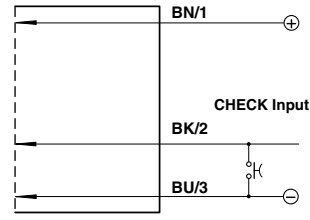

N.B. In caso di carico misto, resistivo e capacitivo, la massima capacità ammissibile (C) è di 0,1μF per tensione e corrente di uscita massime.
NOTE In case of combined load, resistive and capacitive, the maximum admissible capacity (C) is 0,1μF for maximum output voltage and current.

	modelli catarifrangenti/ retro-reflective models	modelli riflessione diretta diffuse reflection models	modelli a barriera through-beam models
impulso a luce/light on	NC	NO	NC
impulso buio/dark on	NO	NC	NO



Curve caratteristiche - Characteristic curves

- Eccesso di guadagno
- Excess gain

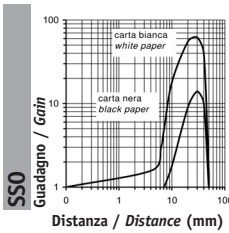

- Eccesso di guadagno
- Excess gain

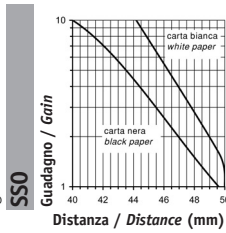

- Eccesso di guadagno
- Excess gain

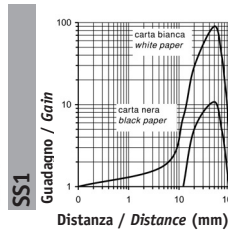

- Eccesso di guadagno
- Excess gain

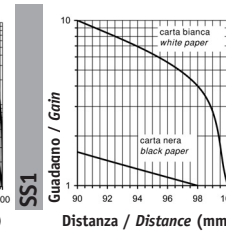

- Eccesso di guadagno
- Excess gain

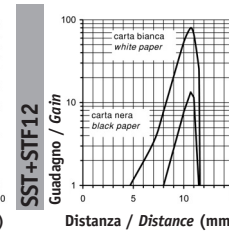

- Eccesso di guadagno
- Excess gain

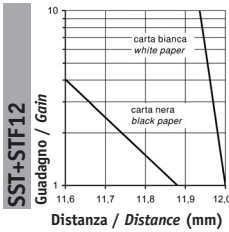

- Eccesso di guadagno
- Excess gain

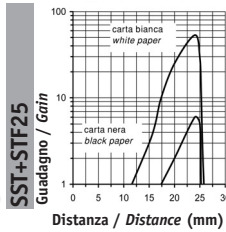

- Eccesso di guadagno
- Excess gain

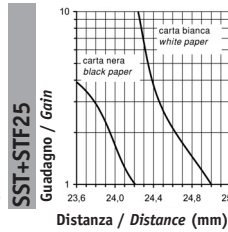

- Disassamento parallelo
- Parallel displacement

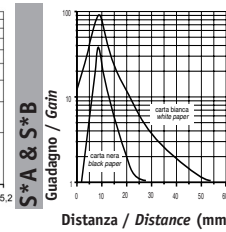

- Eccesso di guadagno
- Excess gain

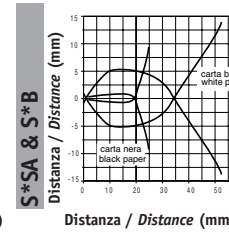

- Eccesso di guadagno
- Excess gain

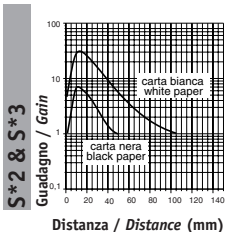

- Disassamento parallelo
- Parallel displacement

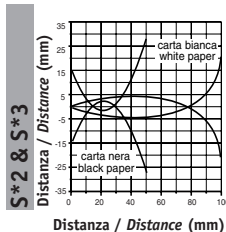

- Distanza/dim. oggetto
- Distance/object dim.

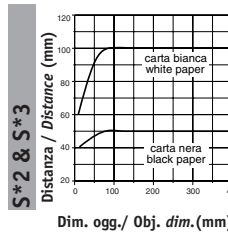

- Eccesso di guadagno
- Excess gain

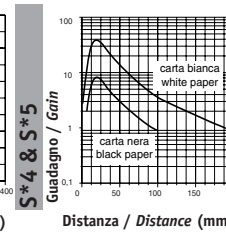

- Disassamento parallelo
- Parallel displacement

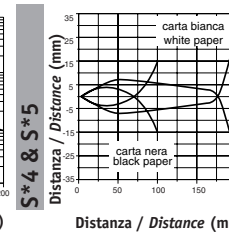

- Distanza/dim. oggetto
- Distance/object dim.

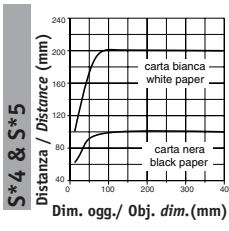

- Eccesso di guadagno
- Excess gain

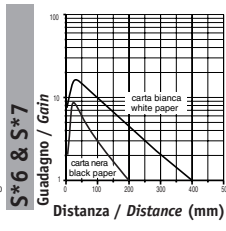

- Disassamento parallelo
- Parallel displacement

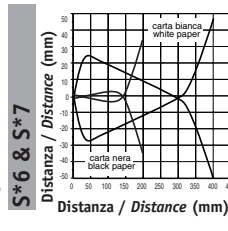

- Distanza/dim. oggetto
- Distance/object dim.

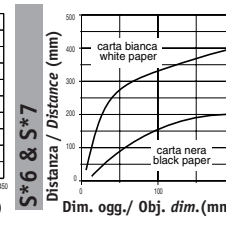

- Eccesso di guadagno
- Excess gain

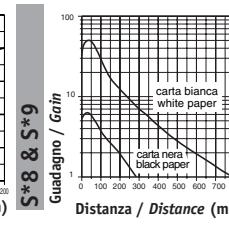

- Disassamento parallelo
- Parallel displacement

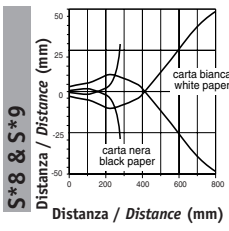

- Distanza/dim. oggetto
- Distance/object dim.

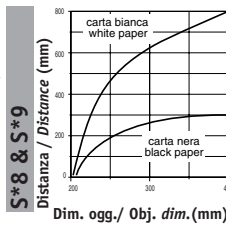

- Eccesso di guadagno
- Excess gain

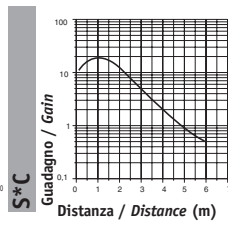

- Disassamento parallelo
- Parallel displacement

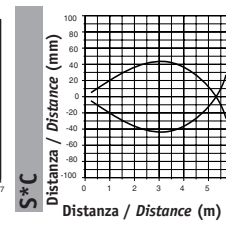

- Eccesso di guadagno
- Excess gain

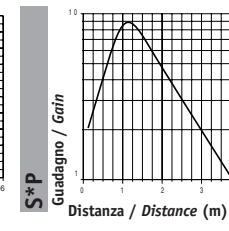

- Disassamento parallelo
- Parallel displacement

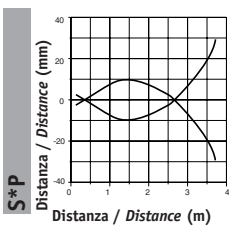

- Eccesso di guadagno
- Excess gain

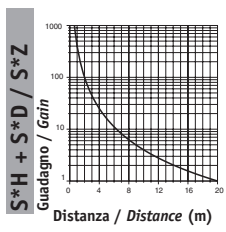

- Disassamento parallelo
- Parallel displacement

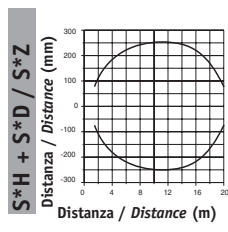

- Disassamento angolare
- Angular displacement

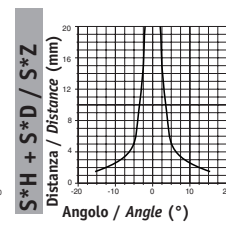

- Mutua interferenza
- Mutual interference

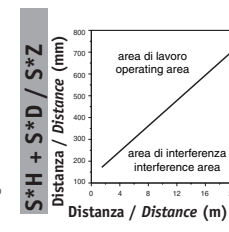

serie SS-SP - serie SS-SP